



CUmini

Follow us



Vmoto Soco

www.vmotosoco.com



Scan QR code to
download e-user manual

USER'S MANUAL

User Instructions

To ensure your safety, please read this manual carefully before riding and make sure you are always following the requirements below:

- Fully understand the information in this manual, including but not limited to the relevant instructions, precautions and warnings.
- Fully understand the operation and contingency measures of CU mini.
- Be fully aware of warning labels of CU mini.
- Please keep the instruction manual properly.

SOCO will NOT take any responsibility resulting from the unauthorized modification, failure to use original spare parts, or installation of components that affect the performance and safety of the bike.

Safety Instructions

DON'T lend your vehicle to someone who can't ride, so as to actively avoid danger.

- Do not ride after you take medications which may affect your riding ability, drink alcohol, or when you are unwell.
- Observe traffic regulations and traffic signs and confirm the surrounding road conditions and bike conditions at any time.
- In rainy and snowy weather, the braking distance will be extended. Please pay attention to slow down and avoid bad weather such as rainstorm and typhoon.
- Wear safety equipment, such as helmet, and appropriate protective clothing if necessary, such as gloves and boots.
- Please cut off the power immediately after usage, take off the key, do not let the child play, so as to avoid the loss to your family and property.
- Perform a basic check each time before riding, so as to confirm the light, brake, tread and tire pressure and check other parts for looseness or abnormal noise, and regularly go to SOCO Service Center for maintenance.

Safety Instructions

- Please pay attention to the safety of CUmini:
 - a) Do not park e-bikes in building foyers, evacuation stairs, walkways and fire exits.
 - b) CU Mini should not be charged or parked in residential buildings, and should be kept away from combustible materials during charging. Charging time should not be too long.
 - c) Please pay attention to the correct use of the battery and warning language. The used battery shall not be dismantled without authorization and shall contact Super Soco local customer service center.
 - d) Please pay attention to the safe use method and warning language of the charger. When replacing the charger, it shall match the model of the battery.
 - e) Please note the precautions related to washing.
 - f) When adjusting the handlebars or saddles, care shall be taken not to expose the safety line marks of the handlebars and saddles (where applicable).
- Check before riding. If there is any abnormality, please timely repair or seek professional repair:
 - a) Check the status of power circuit and lighting circuit, etc. :
 - b) Check whether the front and rear brakes can work normally:
 - c) Check the fixing of handlebars and front and rear wheels:
 - d) Check the tire pressure:
 - e) Check the reflector for damage or contamination.

If you have any questions about this car, please contact Super SOCO local customer service center, who will help then.

- 01 - Check list



x 2

Remote controls



x 1

User manual



x 2

Keys



x 1

Spanner for mirrors

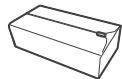

x 1

Charger

- 02 -

Install Battery Pack

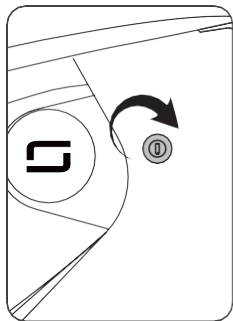

1 Open the saddle and battery compartment.

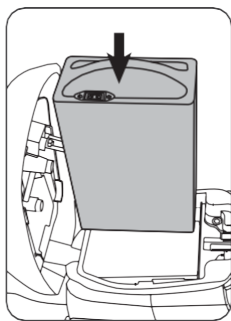

2 Put battery pack in.

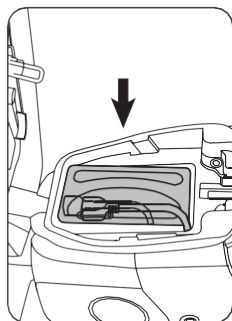

3 Connect power plug.

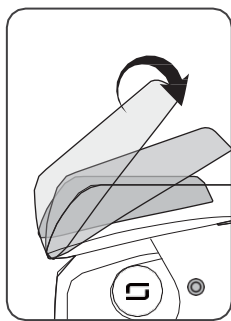

4 Turn on kill switch, put down saddle.

Quick Start

- 03 -

Wear a helmet

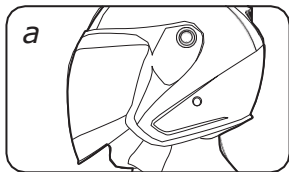

1 Wear a helmet

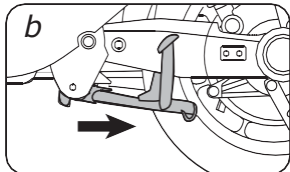

2 Ride on CUmini

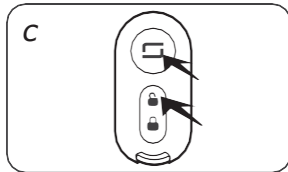

3 Press the "Unlock key" of the intelligent remote control key and then press the "Logo" button to open the vehicle.

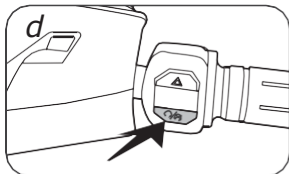

4 Then press the "Parking button"

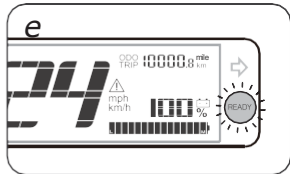

5 The vehicle enters the READY state

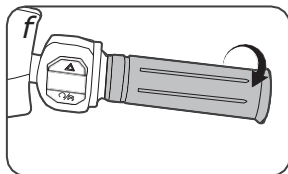

6 Turn throttle, vehicle move.

- 04 -

Download APP

CUmini smart vehicle has GPRS communication function and can be connected with your smart phone. Through SOCO APP, you can use your smartphone to manage and query the vehicle.

Currently, iOS and Android two versions available ,
Please confirm the smartphone operating system specifications before installation.

iOS system : App supports Apple iOS 9.0 and above.

Android system : App support Android 4.4 and above.



SOCO APP

CONTENTS

Accessories checklist	07
Operation guidance	09
Driving guidance	15
Battery guidance	18
APP instructions	19
-----	-----
Maintenance	20
Common problem	21
After-sales service	24

Description of components and parts

a. Schematic diagram of vehicle parts

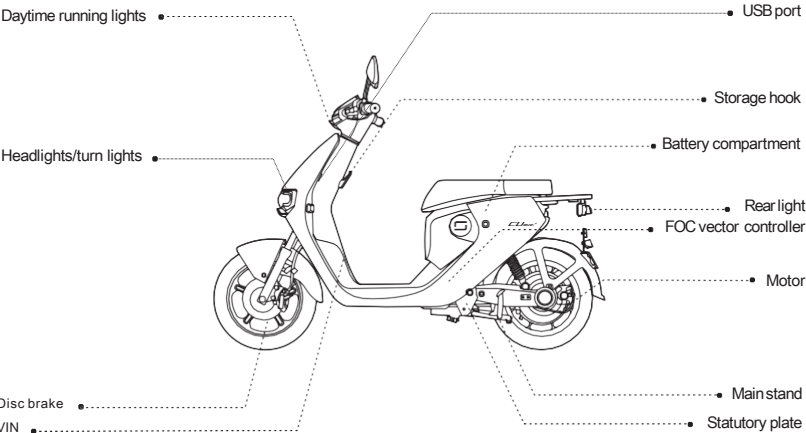

Description of components and parts

a. Schematic diagram of vehicle parts

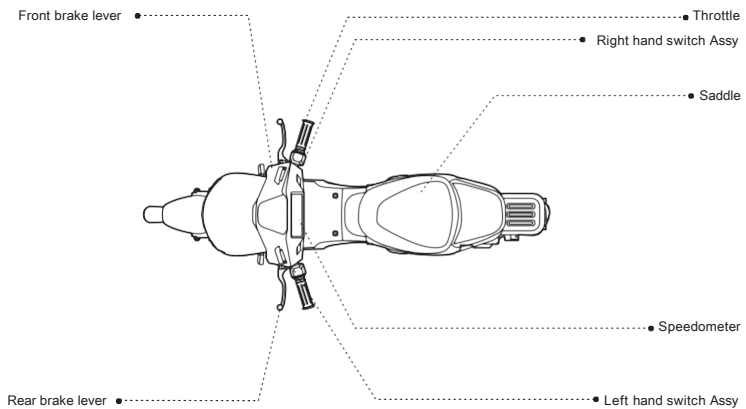

Description of components and parts

b. Speedometer schematic diagram

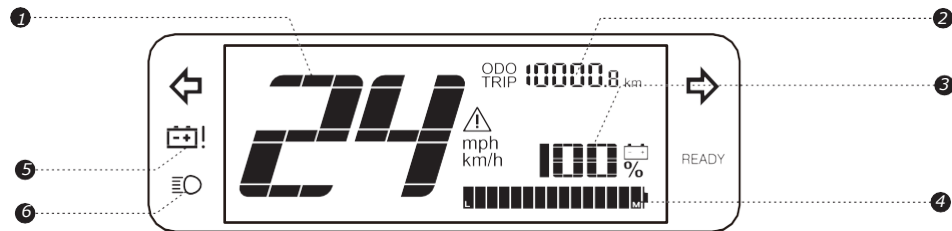

1 Speed display/fault code

Display the current vehicle speed, when the fault light is on, the fault code will be displayed

3 Battery percentage display

Displays the current battery power percentage

4 Charging status display

Charging status indicator/low battery status



Fault prompt accompanied by vehicle fault code display

2 Total mileage/single mileage

Display the total mileage of the vehicle/single mileage

4 Battery display bar

Battery display bar shows the current battery level

6 Headlight status indication

Headlight on/off status indication



Charging indicator flashes when the battery is less than or equal to 10%

Operation guide

a. Left switch

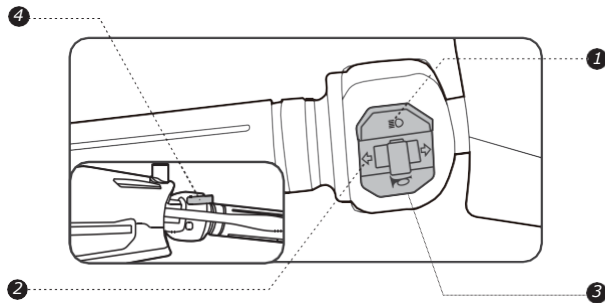

① Front light button

Press the button, front light on/off

② Turning light button

Move to left, left turning lights on;

Move to right, right turning lights on ;

Press the middle "OFF" button, turning lights off.

③ Horn button

Press, horn on; release, horn off.

④ One-Click Fix button

Press the one-click fix button after power on, the vehicle can be driven slowly if there is something wrong with the one hall, throttle error and so on.

Operation guide

b. Right switch

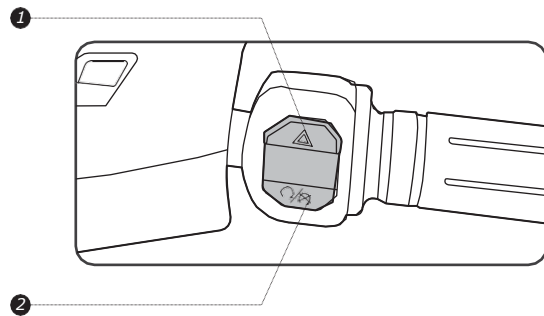

① Hazard flasher

Press the hazard flasher button and turning lights get into the hazard flashers flashing.

② Parking button

Press the button, motorcycle gets into parking state. Then press again to remove parking state and the READY light will be on at the same time

Operation guide

c. Smart remote-control operation

CUmini adopts the second generation of Super Soco Smart Remote Key. You can easily lock or unlock the vehicle by tapping the button within the effective distance. .

① Power on/off button

When the vehicle is unlocked, lightly press this key, the vehicle enters the power-on state, and when the "READY" light is on, lightly twist the handle to start the vehicle; when the vehicle is powered on and remains stationary, lightly press this key, and the vehicle enters the off state. Electric state.

② Unlock button

Tap the "Unlock button" to enter the unlocked state.

③ lock button

When the vehicle is at a standstill, tap the "lock button" to enter the locked state.

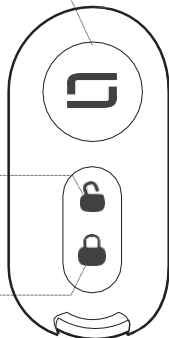

d. Open the battery compartment.

Insert the key and turn the key to the right to open the battery compartment.

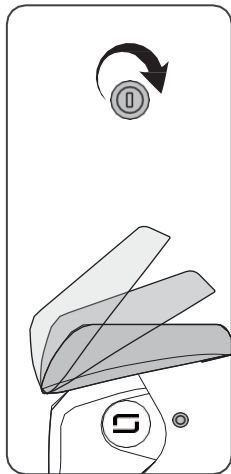
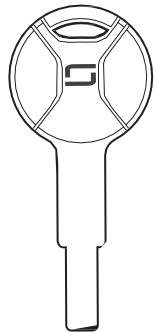

Riding guide

a. Check items before riding.

Before riding the CUmini smart electric bike, please check the following items, which will ensure your safety on the road.

- ① Whether the direction handle is stable and whether the rotation is flexible.
- ② Whether the switches of the left and right handles work normally.
- ③ Whether the throttle works normally.
- ④ To ensure that the tire pressure is normal, it is recommended that the tire pressure be 175-200kpa for the front wheels and 200-225kpa for the rear wheels. (Max tire pressure 280Kpa)
- ⑤ No cracks, damage, wear, puncture or adhesion of foreign objects on the tire surface.
- ⑥ Whether the tread depth is sufficient, if it is worn to the black shaded mark of the tire, it needs to be replaced.
- ⑦ Whether there is any fault warning light on the dashboard after power on.
- ⑧ Whether the battery power is sufficient.
- ⑨ Whether the head and tail lights, brake lights, and direction lights are working properly.
- ⑩ Check if the horn is working properly.
- ⑪ The mirror surface of the rearview mirror is cleaned and adjusted to an appropriate angle.
- ⑫ Whether the break lever and brake system are working properly

Riding guide

b. Start the vehicle

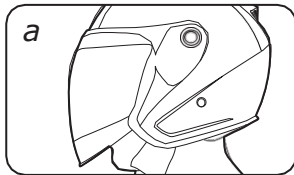

1 Wear a helmet.

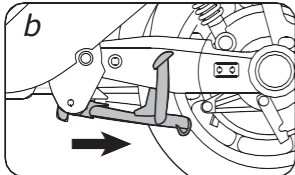

2 Ride on CUmini.

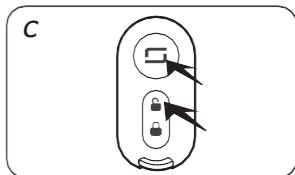

3 Press the 'Unlock key' of the remote control key and then press the 'Logo' button to start the vehicle

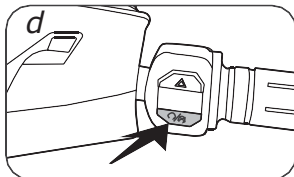

4 Press the 'parking button'

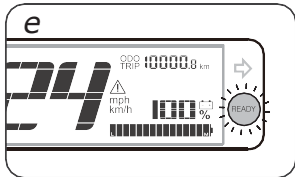

5 Vehicle enters "READY state.

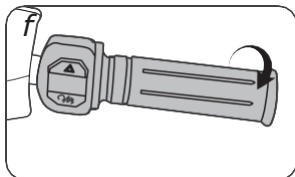

6 Gently turn the handle to ride.

TIPS:

- Before riding, please make sure that the middle brace is folded up ;
- The vehicle must be at a complete standstill before starting. If the vehicle is abnormal, please carefully taxi or push to a safe area. Do not try to restart the vehicle in the moving or lane to avoid danger.

Riding guide

c. Tips for Riding

- ① When the vehicle starts, it should be accelerated slowly to avoid the excessive starting current caused by instant rapid acceleration and increase energy consumption.
- ② On the premise of ensuring safety, the driving speed should be kept constant as far as possible to reduce frequent starting, braking and instant acceleration and increase energy consumption
- ③ The maximum load of this car is 75KG, and overloading is strictly prohibited
- ④ Please press the "parking button" to ensure that the vehicle is in the parking status to prevent accidental sudden start of the vehicle due to unintentional rotation of the handle.
- ⑤ When parking, open the middle support and press the "lock button" of the remote control key.

Battery use instruction

Battery charging 1

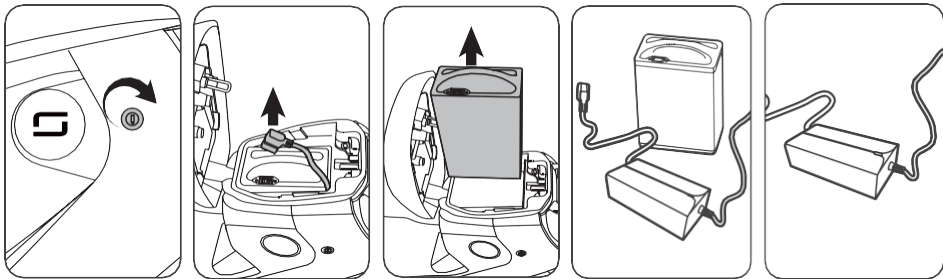

- 1 Open the seat
- 2 Disconnect battery main plug.
- 3 Remove the battery from the battery bin (or not)
- 4 Insert the main plug of the charger into the charging port of the battery pack
- 5 Insert the charger's AC plug into the socket
The indicator light is red when charging normally, and turns green when full.

Battery use instruction

Battery charging 2

- ① Remove the charger
- ② Insert the main plug of the charger into the port under the seat of the vehicle
- ③ The indicator light is red when charging normally, and turns green when fully charged

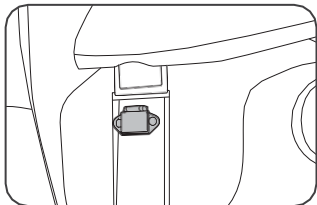

Serious warning:

Avoid raining or flushing the battery, let alone soaking the battery in water. Do not wading the vehicle over the height of the bottom of the battery compartment, otherwise it may cause water to enter the battery, internal short circuit, and permanent battery failure. In this case, it is strictly forbidden to charge the whole vehicle or battery again, otherwise it will cause the battery to catch fire, burn and explode. Please immediately transfer the battery to the outlet for maintenance. In extreme cases, internal fire spontaneously ignites and explodes.

Battery use instruction

- Charging working temperature: 0-40°C, discharging working temperature: -15°C-45°C;
- The battery pack should be charged at the time of use. When not in use for a long time, be sure to remove it from the car for storage;
- Do not charge and park in residential buildings. Keep away from combustibles when charging, and the charging time should not be too long.
- It is strictly forbidden to short-circuit the positive and negative poles of the input and output terminals of the battery pack;
- Avoid the reach of children, and it is strictly forbidden to put it in the fire;
- Strong exercise, impact and squeezing are strictly prohibited;
- The designated special charger must be used, and other brands or models of chargers are strictly prohibited for charging;
- It is strictly forbidden to charge in a confined space or under scorching sun and high temperature, and do not place the charger in the saddle or tail box to charge;
- During the charging process, if the indicator light is abnormal, a peculiar smell appears, or the charger casing is overheated, stop charging immediately and repair or replace the charger.
- Battery packs and chargers have been strictly inspected before leaving the factory, and unauthorized disassembly is strictly prohibited;
- Used batteries cannot be dismantled without authorization, and should be recycled by relevant professional departments.

In case of problems, please contact local customer service center or the company's after-sales service department.

Battery use instruction

c. Storage, maintenance, transportation

- It is strictly forbidden to place the vehicle in the building hall, evacuation stairs, walkway and safety exit.
- If the vehicle is not used for a long time (such as winter, summer or other special circumstances), the battery must be taken out and stored separately and maintained and charged regularly. Otherwise, the battery power may be completely exhausted. Irreversible damage occurs. For such problems, battery failure will not be within the scope of the three guarantees
- When the battery pack needs to be stored for a long time, please charge the battery pack to a half-saturated state (after the battery pack is discharged, charge it with a charger for 3 hours), disconnect the battery from the vehicle to prevent over-discharge of the battery, and place it in Dry and ventilate place, and charge the battery once a month
- Battery packs and chargers should be stored in a clean, dry, and ventilated place, avoid contact with corrosive substances, and keep away from power, fire and heat sources.
- Battery pack storage conditions: ambient temperature 0-25°C, ambient humidity ≤65%RH

Maintenance

Regular maintenance and maintenance can improve the service life and driving safety of the CUmini intelligent electric vehicle. It is recommended that you refer to the following suggestions to take care of your vehicle

a. Maintenance

Regular inspection and maintenance We recommend that you perform the initial inspection and maintenance at the SUPER SOCO authorized service center 1000 kilometers or two months after you purchase the new car. After that, we recommend that you perform regular inspection and maintenance every 3000 kilometers or six months. The SUPER SOCO authorized service center will provide maintenance services for your car (maintenance services may involve costs, please consult the service center staff or official customer service personnel).

b. Daily cleaning and maintenance

Cleaning: Please use clean water and neutral detergent, and use a soft cloth or sponge to clean the surface of the vehicle; metal brushes, sandpaper, etc. are strictly prohibited to wipe the vehicle body to avoid scratching the surface of the vehicle body and parts. After cleaning, wipe the vehicle dry with a dry soft cloth.

Storage: Please park the vehicle in a dry and cool room to reduce sunlight and rain to avoid corrosion of parts and shorten the service life.

c. Warning

- Do not use a strong water jet to directly flush, so as to prevent internal electrical components and lines from intruding or soaking water and causing vehicle mechanical failures or other hidden accidents.
- When storing the vehicle for a long time, disconnect the connection line between the battery and the vehicle to prevent over-discharge of the battery and charge the battery once a month

Common problems and troubleshooting methods

a. Common problems and troubleshooting methods

Error	Causes	Solutions
No power	1. battery is poorly connected. 2. safety fuse burns out or not good connect.	1.connect the power cable appropriately. 2.please replace the safety fuse.
Power on, turning handlebar, motor not work	1.low battery 2.brake handle does not reach the right position. 3.handlebar break down 4.the controller plug is loose. 5.controller break down	1.charge the battery 2.place the brake handle at the right position. 3.change the handlebar 4.re-plug the controller 5.change the controller
Speed is slow or mileage is short	1. low battery 2. flat tyre 3. heavily overloaded 4. brake pads need to be changed 5.battery aging or being scrapped normally	1. charge the battery 2. inflate the tyres to normal tyre pressure before riding 3.form a good habit that keep appropriate load 4.Please change the brake pads on time and check the brake system before riding 5. change the battery
Battery can not be charged	1.poor connect of charger plug 2.the charger is not used in right way 3.battery aging or being scrapped normally	1.check whether the charger plug is at right position 2.use SOCO charger 3.change the battery

Common problems and troubleshooting methods

Error	Causes	Solutions
Error 99 on speedometer	Controller communication error	Please contact with after-sales service or dealer
Error 98 on speedometer	Controller stops working (possibly over current , blocking , under voltage , over temperature)	Please park for a while then start again
Error 97 on speedometer	Controller power tube error	Please contact with after-sales service or dealer
Error 96 on speedometer	Controller hall sensor error	Please contact with after-sales service or dealer
Error 95 on speedometer	Controller handlebar error	Please check the wire of handlebar or contact with after-sales service for replace
Error 94 on speedometer	Battery communication error	Please check the battery connector status , contact with after-sales service or dealer
Error 93 on speedometer	Charging over current	Stop charging then check the charger
Error 92 on speedometer	Charging over voltage	Stop charging then check the charger
Error 91 on speedometer	Battery over temperature	Stop charging , stop riding , try to ride after the temperature of battery dropping

Common problems and troubleshooting methods

Error	Causes	Solutions
Error 90 on speedometer	Battery discharge over current	In case it shows error 90 all the time , stop riding , wait for a moment
Error 89 on speedometer	Charging low temperature	Take out the battery and charge in warm indoor place
Error 88 on speedometer	Discharging low temperature	Store the battery or e-bike in warm indoor place , wait for a moment

Common problems and troubleshooting methods

b. Battery troubleshooting

Battery Status Issues		Causes	Solution
Before using	Battery no power“start”not on	Low battery	Charge battery
In use	When riding with low power , power off occurs when battery capacity drops below 10%	Low battery , low voltage protection , normal phenomenon	Charge battery
In use	Error 88 on instrument	Discharging low temperature	Store the battery or e-bike to warm indoor place , wait for a moment
In use	Error 90 on instrument	Discharging over current	In case it shows error 90 all the time , stop riding. Wait for a moment.
In use	Error 91 on instrument	Discharging over temperature	Stop riding , turn off air switch
In use	Error 94 on instrument	Battery communication error	Wait for a moment Please check the battery connector , Contact with after-sales service or dealer.
In use	Instrument capacity drops after night or a day	CPU , controller , warning devices consume battery , Normal phenomenon	Use normally

Common problems and troubleshooting methods

Battery Status	Issues	Causes	Solution
In use	Mileage is different from official announced	Official announced mileage is the one in special surrounding and status , related to road conditions , whether , temperature , wind drag and load.	Any questions , please contact with after-sales service or dealer.
Storage	Start e-bike , “power”not on	Store battery too long , low Battery.	Charge battery , if can't charge , please contact with After-sales service or dealer.
Charging	Error 89 on instrument	Charge low temperature	Take out the battery then charge it in warm indoor place.
Charging	Error 92 on instrument	Charge over voltage	Stop charging and check the charger
Charging	Chargers become hot during the charging process	During the charging process , inner current of charger is too large , heat emission is too large , metal shell can effectively emit heat,that will lead the temperature of shell is high.	Use normally , use the charge in dry , ventilated place
Battery flooding water	can't use battery normally , can't start the e-bike	Water spray , water immersion , running into deep water cause battery flooding water	Stop using , please contact with after-sales service or dealer.
Battery case break down	Impact and fall on the battery cause damage and crack to the shell	Use causes damage to the battery shell	Stop using , please contact with after-sales service or dealer.



SOCO APP

Currently, iOS and Android two versions available ,
Please confirm the smartphone operating system specifications before installation.

iOS system : App supports Apple iOS 9.0 and above.

Android system : App support Android 4.4 and above.

Download APP



Bind APP

